

Low Pressure Filter LPF up to 280 l/min, up to 50 bar

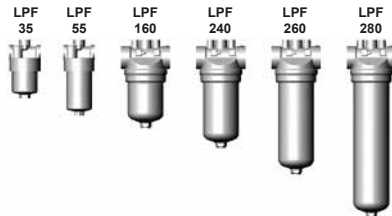

1. TECHNICAL SPECIFICATIONS

1.1 FILTER HOUSING

Construction

The filter housings are designed in accordance with international regulations. They consist of a filter head and a screw-in filter bowl.

Standard equipment:

- without bypass valve
- connection for a clogging indicator

1.2 FILTER ELEMENTS

HYDAC filter elements are validated and their quality is constantly monitored according to the following standards:

- ISO 2941, ISO 2942, ISO 2943, ISO 3724, ISO 3968, ISO 11170, ISO 16889

Contamination retention capacities in g

LPF	Betamicon® (BN4HC)			
	3 µm	5 µm	10 µm	20 µm
35	7.2	8.1	8.6	8.8
55	14.0	15.8	16.6	17.2
160	19.8	22.2	23.5	24.3
240	32.3	36.3	38.4	39.6
260	46.4	52.0	55.0	56.9
280	70.6	79.3	83.9	86.6

LPF	Betamicon® (BN4HC)			
	3 µm	5 µm	10 µm	20 µm
35	5.3	5.2	5.8	6.6
55	10.5	10.3	11.5	13.0
160	12.9	12.6	13.9	15.9
240	21.6	21.1	23.2	26.5
260	32.1	31.5	34.6	39.4
280	48.1	47.1	51.8	59.1

Filter elements are available with the following pressure stability values:

Betamicon® (BN4HC): 20 bar
Betamicon® (BH4HC): 210 bar
Stainl. steel wire mesh (W/HC)*: 30 bar

*only for LPF 160, 240, 260, 280

IMPORTANT:

Only filter elements in ...HC material can be used in LPF filters!

1.3 FILTER SPECIFICATIONS

Nominal pressure	LPF 35, 55: 40 bar LPF 160, 240, 260, 280: 50 bar
Fatigue strength	at nominal pressure 10 ⁶ load cycles from 0 to nominal pressure LPF 35 and 55: 10 ⁷ load cycles at 40 bar
Temperature range	-30 °C to +100 °C
Material of filter head	Aluminium
Material of filter bowl	Aluminium
Type of indicator	VM (Diff. pressure indicator up to 210 bar operating pressure) VL (Diff. pressure indicator up to 40 bar operating pressure - only BF indicator)
Pressure setting of clogging indicator	5 bar (others on request)
Bypass cracking pressure (optional)	6 bar (LPF 160 - 280) 7 bar (LPF 35 - 55) others on request

1.4 SEALS

Perbunan (=NBR)

1.5 INSTALLATION

Inline filter

1.6 SPECIAL MODELS AND ACCESSORIES

- Seals in FPM, EPDM
- With bypass valve (1, 3, 6 or 7 bar)
- Without port for clogging indicator (LPF 160, 240, 260, 280)

1.7 SPARE PARTS

See Original Spare Parts List

1.8 CERTIFICATES AND APPROVALS

On request

1.9 COMPATIBILITY WITH

HYDRAULIC FLUIDS ISO 2943

- Hydraulic oils H to HLPD DIN 51524
- Lubrication oils DIN 51517, API, ACEA, DIN 51515, ISO 6743
- Compressor oils DIN 51506
- Biodegradable operating fluids VDMA 24568 HETG, HEES, HEPG
- Fire-resistant fluids HFC and HFD
- Operating fluids with high water content (> 50 % water content) on request

Symbol for hydraulic systems

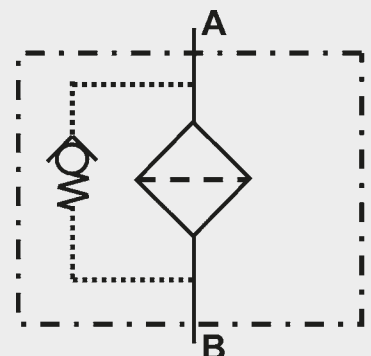

2. MODEL CODE (also order example)

LPF BN/HC 160 G E 10 D 1 . X /-L24

2.1 COMPLETE FILTER

Filter type _____

LPF

Filter material _____

BN/HC Betamicron® (BN4HC)

BH/HC Betamicron® (BH4HC)

W/HC Stainless steel wire mesh (only LPF 160, 240, 260, 280)

Size of filter or element _____

LPF: 35, 55, 160, 240, 260, 280

Operating pressure _____

E = 40 bar (LPF 35, 55)

G = 50 bar (LPF 160, 240, 260, 280)

Type and size of connection _____

Type	Port	Filter size					
		35	55	160	260	240	280
A	M18 x 1.5	●	●				
B	G ½	●	●				
E	G 1¼			●	●	●	●

Filtration rating in µm _____

BN/HC, BH/HC: 3, 5, 10, 20

W/HC: 25, 50, 100, 200 (only LPF 160, 240, 260, 280)

Type of clogging indicator _____

W without port (no clogging indicator)

Y plastic blanking plug in indicator port

A steel blanking plug in indicator port

B visual

C electrical

D visual and electrical

BF visual mobile indicator (only LPF 160, 240, 260, 280)

Return line indicator possible on request!

for other clogging indicators,
see brochure no. 7.050../..

Type code _____

1

Modification number _____

X the latest version is always supplied

Supplementary details _____

B. cracking pressure of bypass valve (e.g. B6 = 6 bar); no details = without bypass valve

BFL BF clogging indicator on left in direction of flow

BFR BF clogging indicator on right in direction of flow

L... light with appropriate voltage (24, 48, 110, 220 Volt)

LED 2 light-emitting diodes up to 24 Volt

SO184 pressure release/oil drain screw

V FPM seals

W suitable for HFA and HFC emulsions

only for clogging
indicators type "D"

2.2 REPLACEMENT ELEMENT

0160 D 010 BN4HC /-V

Size _____

0035, 0055, 0160, 0240, 0260, 0280

Type _____

D

Filtration rating in µm _____

BN4HC, BH4HC: 003, 005, 010, 020

W/HC: 025, 050, 100, 200 (only LPF 160, 240, 260, 280)

Filter material _____

BN4HC, BH4HC, W/HC

Supplementary details _____

V, W (for descriptions, see point 2.1)

2.3 REPLACEMENT CLOGGING INDICATOR

VM 5 D . X /-L24

Type of indicator _____

VM Diff. pressure indicator up to 210 bar operating pressure

VL Diff. pressure indicator up to 50 bar operating pressure (only in conjunction with the "BF" indicator)

Pressure setting _____

5 standard 5 bar, others on request (standard 2 bar on "BF" indicator)

Type of clogging indicator (see Point 2.1) _____

Modification number _____

X the latest version is always supplied

Supplementary details _____

L..., LED, V, W (for descriptions, see point 2.1)

3. FILTER CALCULATION / SIZING

The total pressure drop of a filter at a certain flow rate Q is the sum of the housing Δp and the element Δp and is calculated as follows:

$$\Delta p_{\text{total}} = \Delta p_{\text{housing}} + \Delta p_{\text{element}}$$

$$\Delta p_{\text{housing}} = \text{(see Point 3.1)}$$

$$\Delta p_{\text{element}} = Q \cdot \frac{SK^*}{1000} \cdot \frac{\text{viscosity}}{30}$$

(*see Point 3.2)

For ease of calculation, our Filter Sizing Program is available on request free of charge.

NEW: Sizing online at www.hydac.com

3.1 Δp -Q HOUSING CURVES BASED ON ISO 3968

The housing curves apply to mineral oil with a density of 0.86 kg/dm³ and a kinematic viscosity of 30 mm²/s. In this case, the differential pressure changes proportionally to the density.

LPF 35, 55

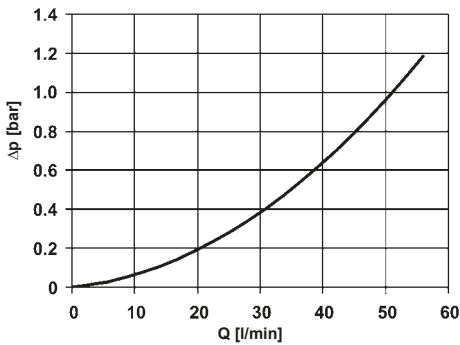

LPF 160, 240, 260, 280

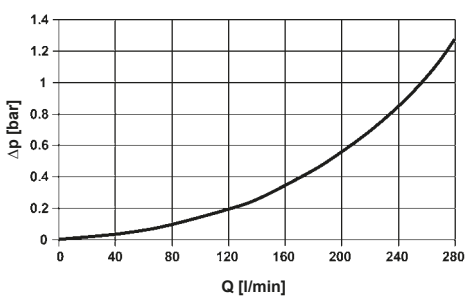

3.2 GRADIENT COEFFICIENTS (SK) FOR FILTER ELEMENTS

The gradient coefficients in mbar/(l/min) apply to mineral oils with a kinematic viscosity of 30 mm²/s. The pressure drop changes proportionally to the change in viscosity.

	BH4HC				W/HC
	3 μm	5 μm	10 μm	20 μm	—
35	47.8	28.1	16.8	10.5	—
55	24.2	14.2	8.5	5.3	—
160	16.8	10.4	5.9	4.4	0.284
240	10.6	6.8	3.9	2.9	0.189
260	8.1	4.8	3.3	1.9	0.131
280	5.7	3.4	1.8	1.6	0.089

BH4HC: LPF 35

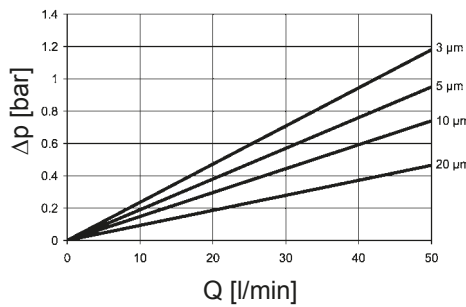

BH4HC: LPF 55

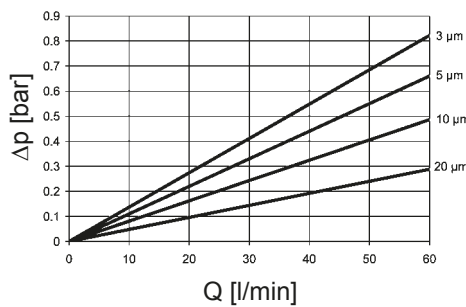

BH4HC: LPF 160

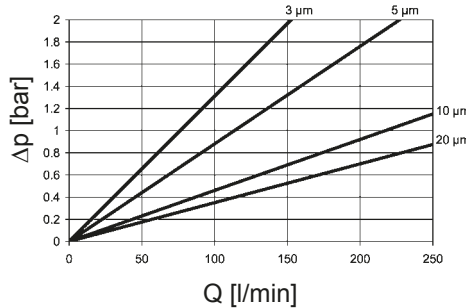

BH4HC: LPF 240

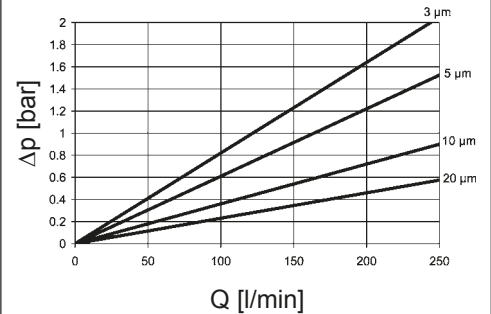

BH4HC: LPF 260

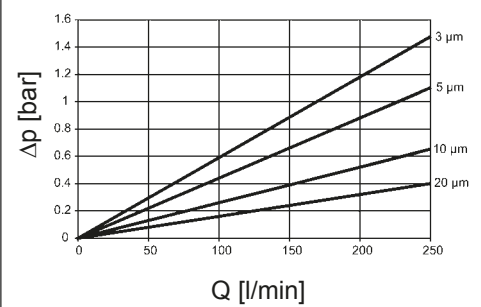

BH4HC: LPF 280

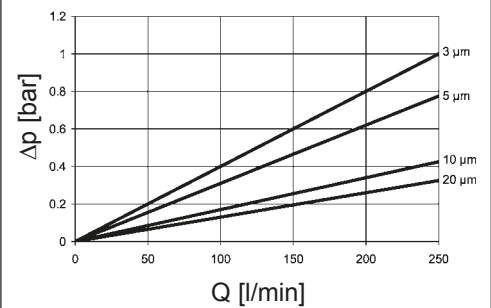

4. DIMENSIONS

LPF 35, 55

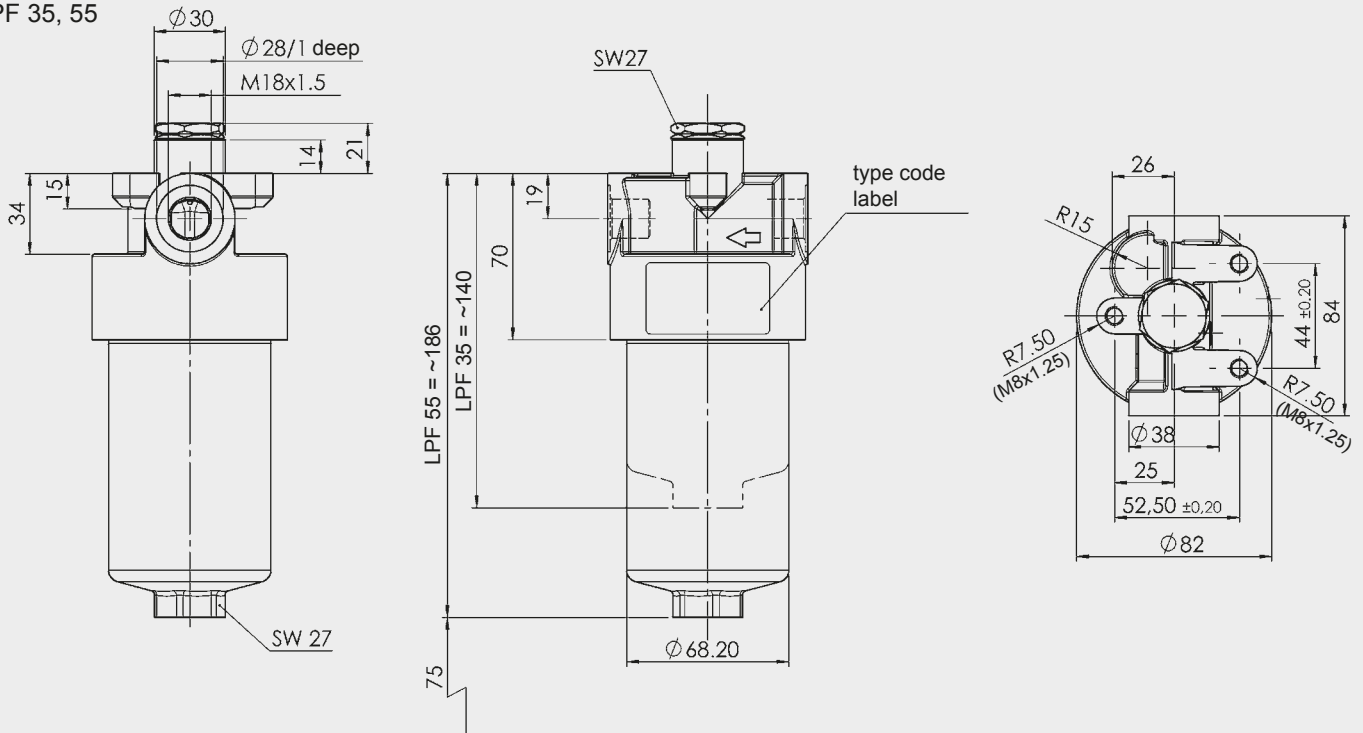

LPF 160, 240, 260, 280

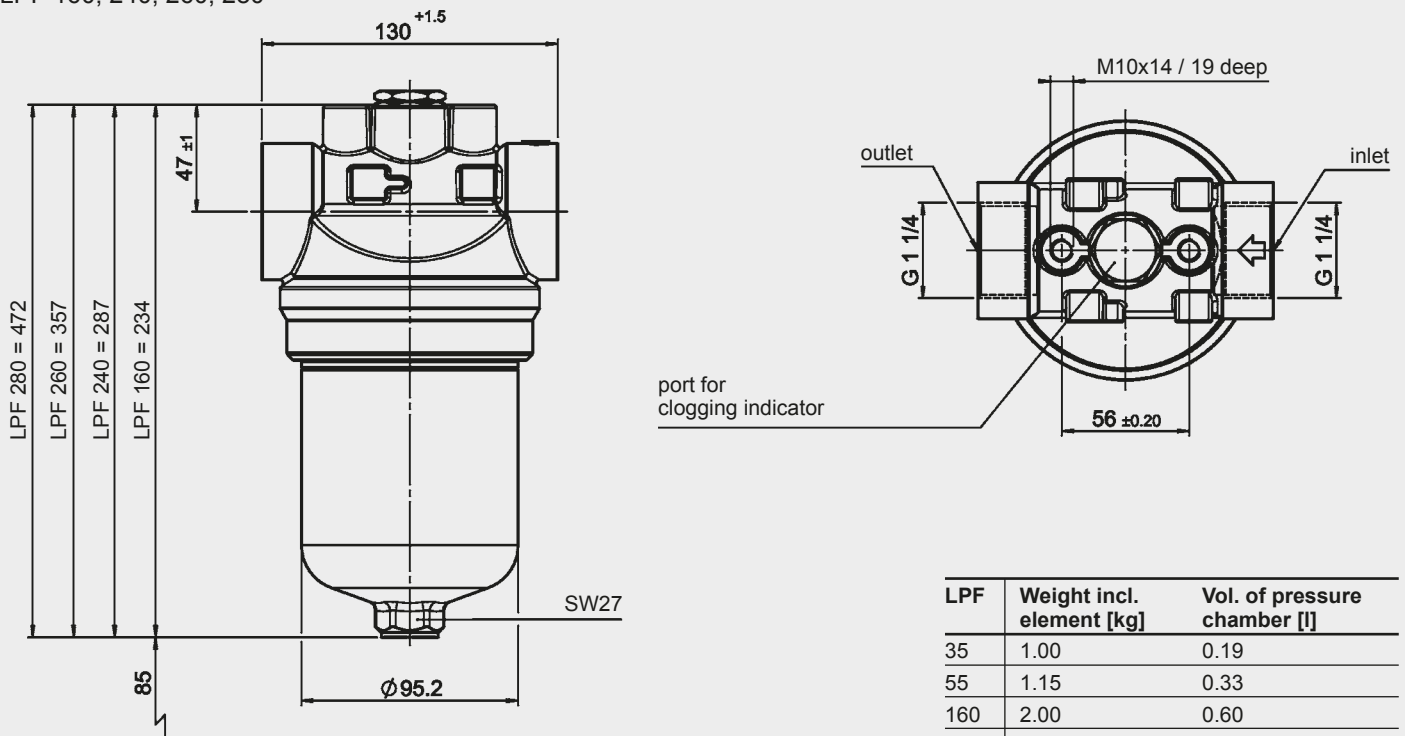

LPF	Weight incl. element [kg]	Vol. of pressure chamber [l]
35	1.00	0.19
55	1.15	0.33
160	2.00	0.60
240	2.31	0.90
260	2.76	1.30
280	3.28	1.70

NOTE

The information in this brochure relates to the operating conditions and applications described.
For applications or operating conditions not described, please contact the relevant technical department.
Subject to technical modifications.

HYDAC Filtrertechnik GmbH
Industriegebiet
D-66280 Sulzbach/Saar
Tel.: 0 68 97 / 509-01
Fax: 0 68 97 / 509-300
Internet: www.hydac.com
E-Mail: filter@hydac.com