

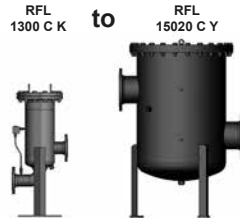

Inline Filter RFL Welded Version up to 15000 l/min, up to 16 bar



1. TECHNICAL SPECIFICATIONS

1.1 FILTER HOUSING

Construction

The filter housings are designed in accordance with international regulations. They consist of a two-piece filter housing with a bolt-on cover plate.

Standard equipment:

- stand
- inlet and outlet are positioned at different heights on opposite sides
- connections for venting and draining
- connection for a clogging indicator

1.2 FILTER ELEMENTS

HYDAC filter elements are validated and their quality is constantly monitored according to the following standards:

- ISO 2941, ISO 2942, ISO 2943
- ISO 3724, ISO 3968, ISO 11170
- ISO 16889

Contamination retention capacities in g

		Betamicon® (BN4HC)			
RFL	Elements	3 µm	5 µm	10 µm	20 µm
130x	1x1300 R	181.0	200.7	241.4	273.1
132x	1x2600 R	369.4	409.4	492.5	557.2
250x	3x0850 R	336.3	372.6	448.5	507.3
252x	3x1700 R	689.4	764.1	919.2	1039.8
400x	5x0850 R	560.5	621.0	747.5	845.5
402x	5x1700 R	1149.0	1273.5	1532.0	1733.0
520x	4x1300 R	724.0	802.8	965.6	1092.4
522x	4x2600 R	1477.6	1637.6	1970.0	2228.8
650x	5x1300 R	905.0	1003.5	1207.0	1365.5
652x	5x2600 R	1847.0	2047.0	2462.5	2786.0
780x	6x1300 R	1086.0	1204.2	1448.4	1638.6
782x	6x2600 R	2216.4	2456.4	2955.0	3343.2
1500x	10x1300 R	1810.0	2007.0	2414.0	2731.0
1502x	10x2600 R	3694.0	4094.0	4925.0	5572.0

Filter elements are available with the following pressure stability values:

Betamicon® (BN4HC):	20 bar
Optimicon® Power (ON/PO):	10 bar
Paper (P/HC):	10 bar
Stainl. st. wire mesh (W/HC):	20 bar
Stainl. steel fibre (V):	30 bar
Betamicon®/Aquamicron® (BN4AM):	10 bar
Aquamicron® (AM):	10 bar

1.3 FILTER SPECIFICATIONS

Nominal pressure	16 bar
Temperature range	-10 °C to +100 °C
Material of filter housing and cover plate	RFL 1300 to 15020: Welded steel RFL 1303 to 15023: Stainl. st. 1.4571
Type of clogging indicator	VM (differential pressure measurement up to 210 bar operating pressure)
Pressure setting of the clogging indicator	2 bar (others on request)
Bypass cracking pressure	3 bar (others on request)

1.4 SEALS

NBR (=Perbunan)

1.5 INSTALLATION

Inline filter

1.6 SPECIAL MODELS AND ACCESSORIES

- Drain and vent ports with ball valves or other shut-off valves
- Inlet and outlet positioned one above the other
- Counter flanges available for all sizes
- Venting line with sight gauges
- Cover plate lifting device

1.7 SPARE PARTS

See Original Spare Parts List

1.8 CERTIFICATES AND APPROVALS

Material code (final digit of filter size) - 1:

These filters can be supplied with manufacturer's test certificates O and M to DIN 55350, Part 18. Test certificates 3.1 to DIN EN 10204.

Material code (final digit of filter size) - 3:

Filters for use in separation technology with low viscosity, high viscosity and aggressive fluids as well as gaseous media.*

* These filters are available from HYDAC Process Technology division.

1.9 COMPATIBILITY WITH HYDRAULIC FLUIDS ISO 2943

- Hydraulic oils H to HLPD DIN 51524
- Lubrication oils DIN 51517, API, ACEA, DIN 51515, ISO 6743
- Compressor oils DIN 51506
- Biodegradable operating fluids VDMA 24568 HETG, HÉES, HEPG
- Fire-resistant fluids HFA, HFB, HFC and HFD
- Operating fluids with high water content (> 50 % water content) on request

1.10 IMPORTANT INFORMATION

- Filter housings must be earthed.
- When using electrical clogging indicators, the electrical power supply to the system must be switched off before removing the clogging indicator connector.
- Filters must be flexibly mounted and not fixed rigidly to the floor or used as a pipe support.

Symbol for hydraulic systems

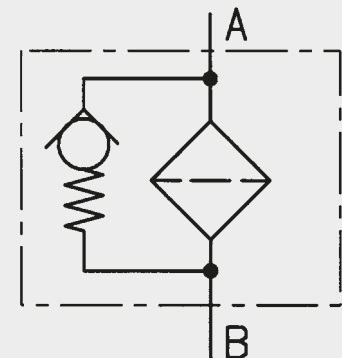

2. MODEL CODE (also order example)

RFL BN/HC 1300 C K 10 D 1 . X /-L24

2.1 COMPLETE FILTER

Filter type _____

RFL

Filter material of element _____

BN/HC Betamicon® (BN4HC) P/HC Paper AM Aquamicon®
 V Stainless steel fibre W/HC Wire mesh BN/AM Betamicon®/Aquamicon®
 ON/PO Optimicon® Power *

Size of filter or element _____

RFL: 1300, 1303, 1320, 1323, 2500, 2503, 2520, 2523, 4000, 4003, 4020, 4023, 5200, 5203,
 5220, 5223, 6500, 6503, 6520, 6523, 7800, 7803, 7820, 7823, 15000, 15003, 15020, 15023

Operating pressure _____

C = 16 bar

Type and size of connection _____

Type	Port thread	Filter size							
		1300 1303	1320 1323	2500 2503 2520 2523	4000 4003 4020 4023	5200 5203 5220 5223	6500 6503 6520 6523	7800 7803 7820 7823	15000 15003 15020 15023
K	DIN DN 40	●	●						
L	DIN DN 50	●	●	●					
M	DIN DN 65	●	●	●					
Q	DIN DN 80	●	●	●	●	●			
R	DIN DN 100	●	●	●	●	●	●	●	
U	DIN DN 125		●	●	●	●	●	●	
V	DIN DN 150			●	●	●	●	●	
W	DIN DN 200				●	●	●	●	●
X	DIN DN 250					●	●	●	●
Y	DIN DN 300								●

Filtration rating in µm _____

BN/HC, ON/PO*, V: 3, 5, 10, 20 P/HC: 10, 20 AM: 40
 W/HC: 25, 50, 100, 200 BN4AM: 3, 10

Type of clogging indicator _____

Y plastic blanking plug in indicator port
 A stainless steel blanking plug in indicator port
 B visual
 C electrical
 D visual and electrical
 for other clogging indicators, see brochure no. 7.050../..

Type code _____

1

Modification number _____

X the latest version is always supplied

Supplementary details _____

B. special cracking pressure of bypass (e.g. B1 = 1 bar)
 DH cover plate lifting device
 KB without bypass valve
 L... light with appropriate voltage (24V, 48V, 110V, 220V)
 LED 2 light emitting diodes up to 24 Volt
 OR O-ring groove on the DIN flange (inlet and outlet) to Rexroth standard AB 22-04
 RE sealing strip E on the flange (inlet and outlet): surface finish 3.6 µm
 V FPM seals
 33 inlet and outlet positioned one above the other
 only for clogging indicators type "D"

2.2 REPLACEMENT ELEMENT

1300 R 010 BN4HC /-V

Size _____

0850, 1300, 1700, 2600

Type _____

R

Filtration rating in µm _____

BN4HC, ON/PO*, V: 003, 005, 010, 020 P/HC: 010, 020 AM: 040
 W/HC: 025, 050, 100, 200 BN4AM: 003, 010

Filter material _____

BN4HC, ON/PO *, V, W/HC, P/HC, BN4AM, AM

Supplementary details _____

V (for descriptions, see point 2.1)

2.3 REPLACEMENT CLOGGING INDICATOR

VM 2 D . X /-L24

Type _____

VM differential pressure indicator up to 210 bar operating pressure

Pressure setting _____

2 standard 2 bar, others on request

Type of clogging indicator (see Point 2.1) _____

Modification number _____

X the latest version is always supplied

Supplementary details _____

L..., LED, V (for descriptions, see point 2.1)

* Optimicon® Power only in filtration ratings 5, 10 and 20 µm

3. FILTER CALCULATION / SIZING

The total pressure drop of a filter at a certain flow rate Q is the sum of the housing Δp and the element Δp and is calculated as follows:

$$\Delta p_{\text{total}} = \Delta p_{\text{housing}} + \Delta p_{\text{element}}$$

$$\Delta p_{\text{housing}} = (\text{see Point 3.1})$$

$$\Delta p_{\text{element}} = Q \cdot \frac{SK^*}{1000} \cdot \frac{\text{viscosity}}{30}$$

(*see point 3.2)

For ease of calculation, our Filter Sizing Program is available on request free of charge.

NEW: Sizing online at www.hydac.com

3.1 Δp -Q HOUSING CURVES BASED ON ISO 3968

The housing curves apply to mineral oil with a density of 0.86 kg/dm³ and a kinematic viscosity of 30 mm²/s. In this case, the differential pressure changes proportionally to the density.

RFL 1300, 1303

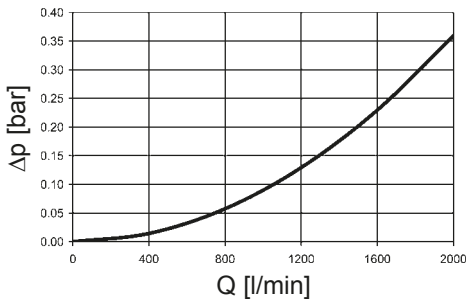

RFL 1320, 1323

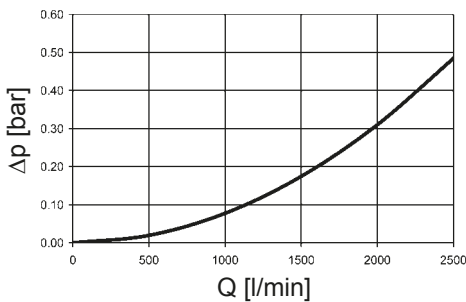

RFL 2500, 2503, 2520, 2523

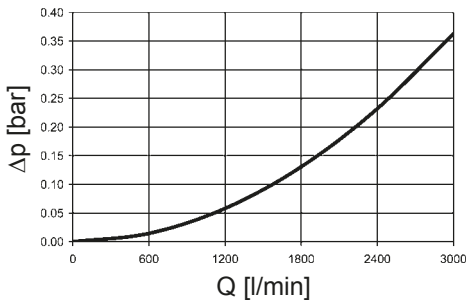

RFL 4000, 4003, 4020, 4023

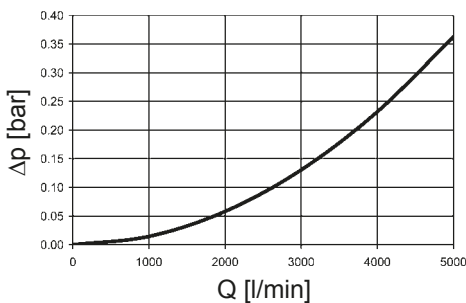

RFL 5200, 5203, 5220, 5223

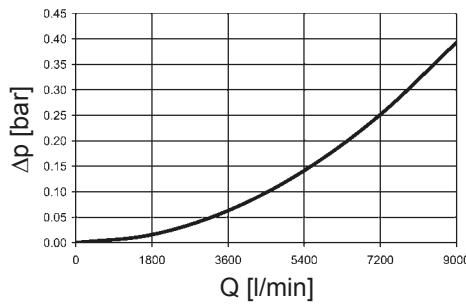

RFL 6500, 6503, 6520, 6523

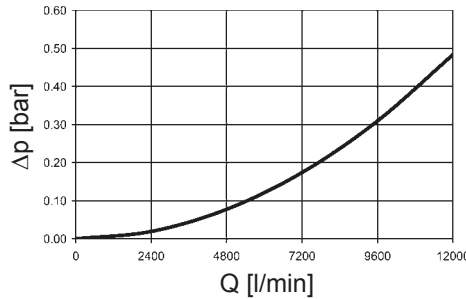

RFL 7800, 7803, 7820, 7823

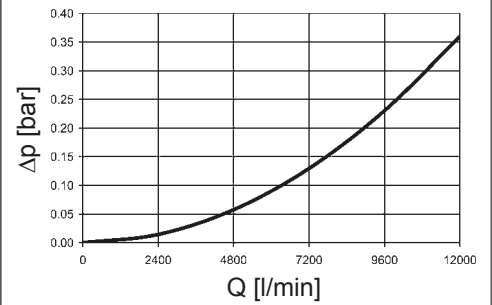

RFL 15000, 15003, 15020, 15023

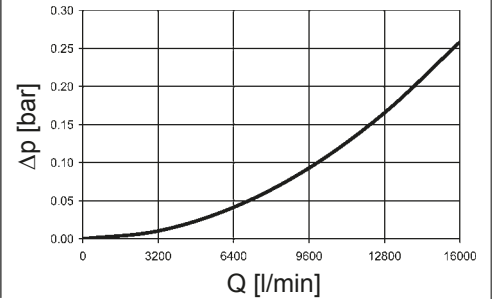

3.2 GRADIENT COEFFICIENTS (SK) FOR FILTER ELEMENTS

The gradient coefficients in mbar/(l/min) apply to mineral oils with a kinematic viscosity of 30 mm²/s. The pressure drop changes proportionally to the change in viscosity.

RFL	V				W/HC	ON/PO		
	3 μm	5 μm	10 μm	20 μm	-	5 μm	10 μm	20 μm
850	0.8	0.6	0.4	0.3	0.052	0.28	0.24	0.16
1300	0.5	0.4	0.3	0.2	0.048	0.18	0.15	0.10
1700	0.4	0.3	0.2	0.1	0.025	0.13	0.11	0.07
2600	0.3	0.2	0.1	0.1	0.017	0.08	0.07	0.05

BN4HC: RFL 850

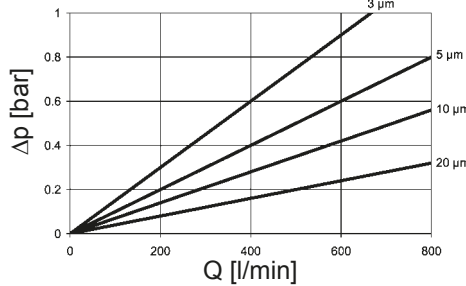

BN4HC: RFL 1300

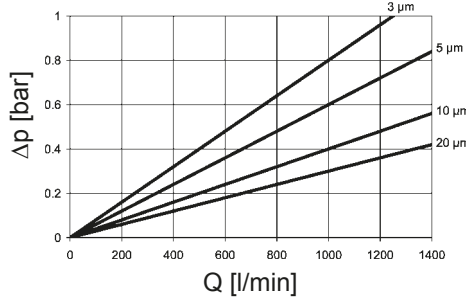

BN4HC: RFL 1700

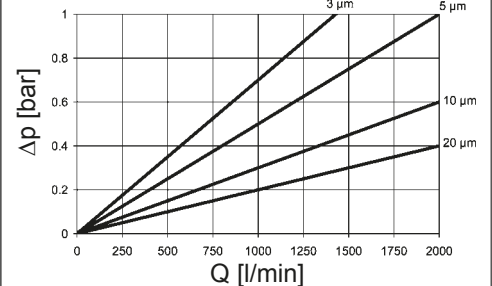

BN4HC: RFL 2600

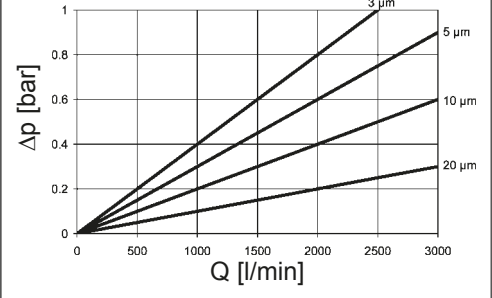

4. DIMENSIONS

RFL 1300 - 1320

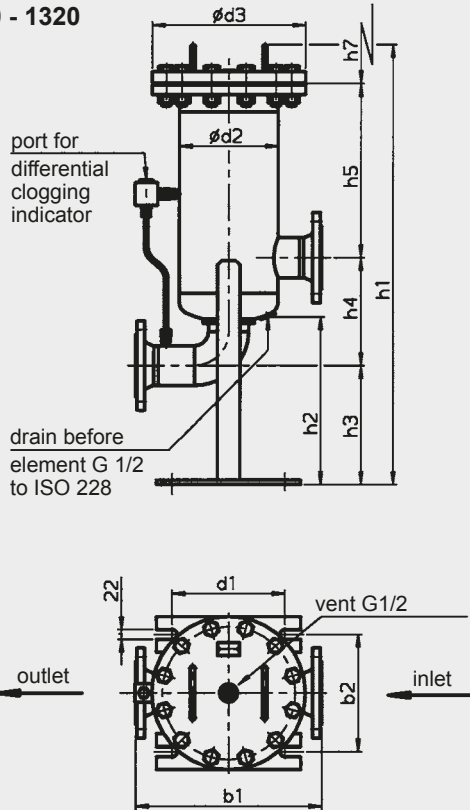

RFL 2500 - 15020

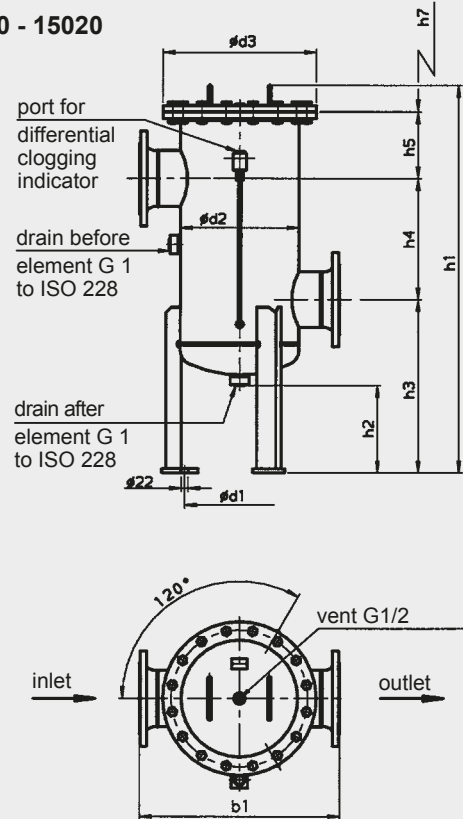

RFL	Flange port	b1	b2	d1	d2	d3	h1	h2	h3	h4	h5	h7	Weight including element [kg]	Volume of pressure chamber [l]	
130x/132x	DIN DN 40	412	260	250	219.1	340	972/1416	370	294	212	384/824	500/940	64.1/78.1	18/33	
	DIN DN 50								266	240	384/824		64.1/78.1	18/33	
	DIN DN 65								279	227	384/824		65.1/79.1	18/33	
	DIN DN 80								266	240	384/824		67.1/81.1	19/34	
	DIN DN 100								253	275	362/802		69.1/83.1	19/34	
132x	DIN DN 125	480	260	250	219.1	340	/1416	370	215	291	/824	/940	87.1	/36	
250x/252x	DIN DN 50	466	312	250	273	360	942/1332	220	378	270	222/612	420/810	73.9/82.4	34/54	
	DIN DN 65								408	350	160/550		420/810	70.9/85.4	36/56
	DIN DN 80								388	410	120/510		420/810	72.9/87.4	36/56
	DIN DN 100								438	304	236/626		420/810	75.9/90.4	40/60
	DIN DN 125								438	380	160/550		420/810	79.9/94.4	40/60
	DIN DN 150								438	365	175/565		420/810	83.9/98.4	45/65
400x/402x	DIN DN 80	600	-	330	355.6	460	1079/1469	266	475	410	115/505	420/810	119.5/145.0	64/99	
	DIN DN 100								475	304	221/661		420/810	121.5/147.0	65/100
	DIN DN 125								525	380	185/575		420/810	127.5/153.0	75/110
	DIN DN 150								525	365	200/590		420/810	133.5/159.0	75/110
	DIN DN 200								525	365	235/625		420/810	140.5/166.0	83/118
520x/522x	DIN DN 80	600	-	380	406.4	510	1144/1584	244	465	410	191/631	500/940	158.4/202.4	89/142	
	DIN DN 100								465	304	297/737		420/810	160.4/204.4	90/143
	DIN DN 125								525	380	271/711		420/810	170.4/214.4	104/157
	DIN DN 150								525	365	286/726		420/810	175.4/219.4	106/159
	DIN DN 200								525	365	286/726		420/810	179.4/223.4	110/162
	DIN DN 250								560	450	236/676		420/810	194.4/238.4	125/178
400x/402x	DIN DN 80	600	-	330	355.6	460	1079/1469	266	475	410	115/505	420/810	119.5/145.0	64/99	
	DIN DN 100								475	304	221/661		420/810	121.5/147.0	65/100
	DIN DN 125								525	380	185/575		420/810	127.5/153.0	75/110
	DIN DN 150								525	365	200/590		420/810	133.5/159.0	75/110
	DIN DN 200								525	365	235/625		420/810	140.5/166.0	83/118
780x/782x	DIN DN 100	740	-	480	508	620	1260/1700	255	540	304	336/776	500/940	225.6/282.6	161/246	
	DIN DN 125								540	380	260/700		420/810	229.6/286.6	162/247
	DIN DN 150								540	365	275/715		420/810	234.6/291.6	163/248
	DIN DN 200								600	460	240/680		420/810	249.6/306.6	190/275
	DIN DN 250								600	450	250/690		420/810	259.6/316.6	194/279
1500x/1502x	DIN DN 200	1000	-	690	711	830	1425/1865	263	655	365	330/770	500/940	476.0/570.0	391/558	
	DIN DN 250								655	450	245/685		420/810	488.0/582.0	397/564
	DIN DN 300								670	515	235/675		420/810	513.0/607.0	426/593

NOTE

The information in this brochure relates to the operating conditions and applications described.
For applications or operating conditions not described, please contact the relevant technical department.
Subject to technical modifications.

HYDAC Filtrertechnik GmbH
Industriegebiet
D-66280 Sulzbach/Saar
Tel.: 0 68 97 / 509-01
Fax: 0 68 97 / 509-300
Internet: www.hydac.com
E-Mail: filter@hydac.com